

# SPOT LAMP Installation Manual

1. Instruction Symbols / Definitions
2. Basic Required Hand Tools
3. HYUNDAI Accessories
4. Installation Method

**Vehicle Model** TK1  
**Model Year** 2025  
**HKMC Part No.** DV823AB000  
**Accessories** DOOR SPOT LAMP  
**Difficulty** (B)

Note : Difficulty stated above reflects the minimum level of expertise required to install the accessory

## 1. Instructional Symbols / Definitions

	It indicates a warning. Be aware that it can lead to serious bodily harm or vehicle damage.		It indicates a quality. Be sure to check before moving forward.	It represents the use of safety equipment.	
	Be aware that it may cause personal injury or damage on electronic components.		It represents working hand tools that are necessary to complete this step.		
	Be aware of damage on the vehicle and components.		It specifies installation methods and processes.		
				Mask	Safety Goggles
				Gloves	Hearing Protector

## 2. Basic Required Hand Tools



Gloves



Plastic Spatula



Screwdriver(+)



Longnosed Pliers



Electric drill



Ø20 Hole saw

### ※ PRECAUTIONS

1. Please read this Installation Manual before installing the product.
2. The product should be installed at the correct location as instructed in this manual.
3. Move the vehicle to a safe place before installing the product.
4. Do not place working hand tools on the painted surfaces, dashboard pad, console and floor carpet/mat.
5. Always wear gloves and appropriate safety gear in accordance with the situation.

## 3. Accessories



①



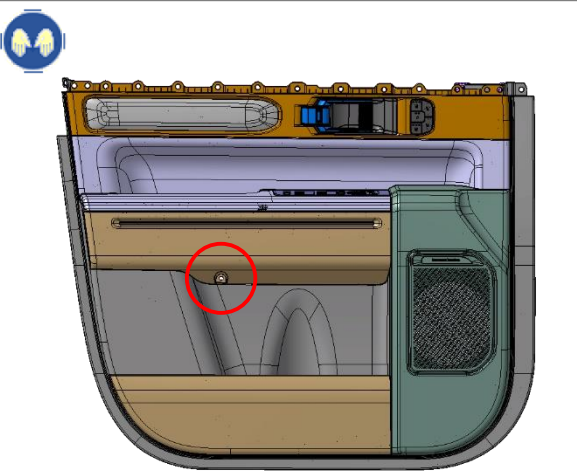

NO	QTY	Description
1	2	DOOR SPOT LAMP ASSY

## 4. Installation Method



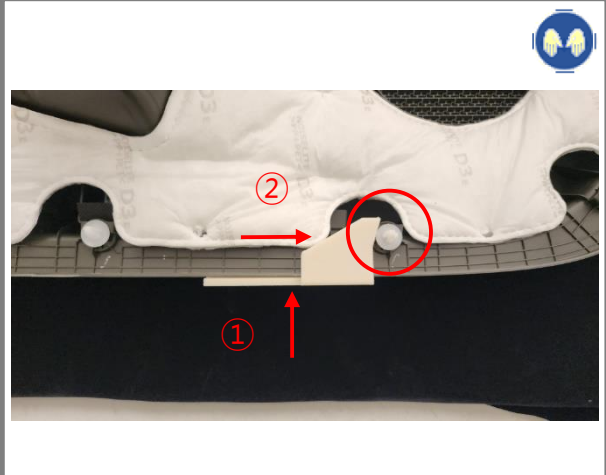

	screwdriver (+)	<b>1</b>
<b>N O T E</b>	<ol style="list-style-type: none"> <li>1. Remove the screws from the display.</li> <li>2. Remove the door trim.</li> </ol>	
	Be careful not to damage the door trim when removing it.	





	JIG	<b>2</b>
<b>N O T E</b>	1. Place the JIG on the reference point as shown in the figure.	
	<ol style="list-style-type: none"> <li>① Put the jig close to the door trim.</li> <li>② Fit the jig against the fastener boss.</li> </ol>	



		<b>3</b>
<b>N O T E</b>	<ol style="list-style-type: none"> <li>1. After positioning the JIG exactly on the reference point of the door trim, mark it using a punch.</li> <li>2. Punch the marked area using a 22mm hole saw.</li> </ol>	
	Be careful not to damage the trim when drilling holes.	



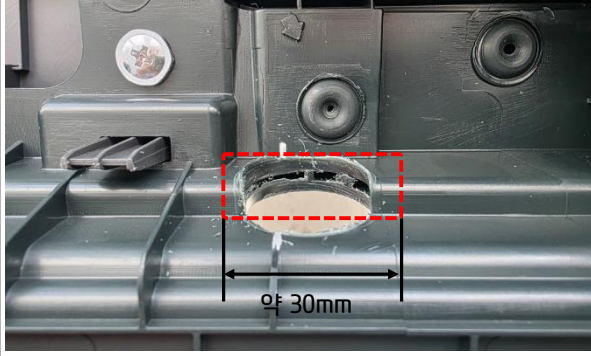

		<b>4</b>
<b>N O T E</b>	1. Remove BURR from the punched area using a deburring tool.	
	Be careful not to over-use the deburring tool as this may expose the punched surface.	

## 4. Installation Method





약 30mm

🔧		<b>5</b>
<b>N O T E</b>	1. After punching, cut the red marking inside the trim to about 30mm as shown in the picture above.	
⚠️	Be careful not to injure or damage the inside of the trim when cutting.	



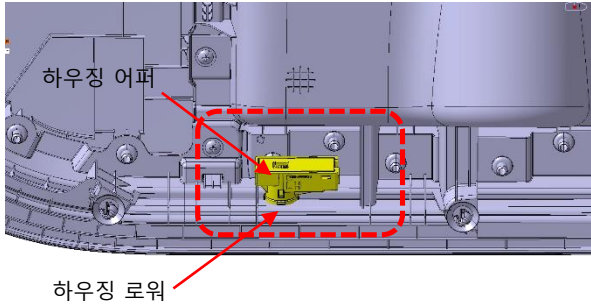

🔧		<b>6</b>
<b>N O T E</b>	1. Cut the interference part as shown in the picture above..	
⚠️		



하우징 로워





🔧		<b>7</b>
<b>N O T E</b>	1. Align the lower housing of the door spot lamp with the upper housing and assemble it into the punched hole. 2. Assemble the upper housing of the door spot lamp with the lower housing.	
⚠️		

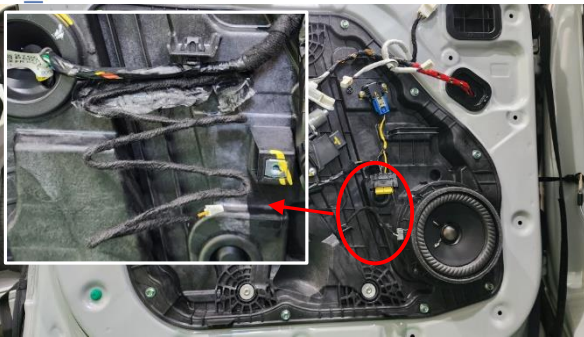







🔧		<b>8</b>
<b>N O T E</b>	1. Check whether the lower part of the door trim is assembled.	
⚠️		

## 4. Installation Method

	
	
	9
<b>N O T E</b>	<ol style="list-style-type: none"><li>1. Remove the insulation tape from the area shown in the photo above.</li><li>2. Separate and extract the wires and connectors.</li></ol>
	Be careful not to damage other wiring when removing the insulating tape.

	
	
	10
<b>N O T E</b>	<ol style="list-style-type: none"><li>1. Check whether the door spot lamp is on.</li><li>2. After checking the alignment of the logo lens image and the door trim, assemble the door trim.</li></ol>
	

	
	
<b>N O T E</b>	
	

	
	
<b>N O T E</b>	
